

# ➤ Instructions

Thule Arcos M/L  
9064, 9065

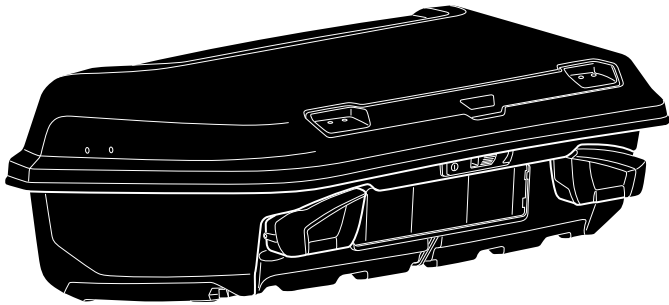

- EN** Cargo box for mounting rear of the car  
**FR** Coffre à monter à l'arrière de la voiture  
**ES** Caja para montar en la parte posterior del coche  
**DE** Cargobox zur Befestigung hinten am Wagen  
**NL** Laadbak voor montage achter op de auto  
**PT** Bagageiro para instalação na traseira do veículo  
**IT** Box per il montaggio posteriore sull'auto  
**SV** Lastbox för montering baktill på bilen  
**DK** Bagageboks til montering bagpå bilen  
**NO** Lasteboks for montering bak på bilen  
**FI** Auton takaosaan asennettava kuljetuslaatikko  
**IS** Flutningskassi festur að aftan á bíl  
**ET** Pagasiboks kinnitus auto tagaosalale  
**LV** Kravas kaste uzstādīšanai automašīnas aizmugurē  
**LT** Bagažinė, skirta užpakalinei daliai prie automobilio pritvirtinti  
**RU** Грузовой бокс для установки сзади автомобиля  
**UK** Чохол для вантажу для кріплення ззаду на автомобіль  
**PL** Box bagażowy montowany z tyłu samochodu  
**CS** Převážní box pro montáž na zadní část vozidla  
**HU** Az autó hátuljára felszerelhető poggyászdoboz  
**RO** Cutie de transport pentru montare în spatele automobilului  
**SK** Prepravná debna s montážou na zadnú stranu vozidla  
**SL** Tovorni kovček za montažo na zadnji del avtomobila  
**BG** Куптия за багаж за монтиране отзад на автомобилa

- HR** Kutija za teret koja se postavlja na stražnji kraj automobila  
**EL** Μπαγάζι για κοτσάδικο  
**TR** Aracın arkasına monte edilen eşya kutusu  
**MT** Kaxxa għat-tagħbija li tintrama fuq in-naħa ta' wara tal-karozza

**HE** ארגז מטען להרכבה מאחור על הרכב  
**AR** صندوق حمولة للتثبيت في الجزء الخلفي للسيارة

- ZH (CN)** 车辆后置安装载物箱  
**ZH (TR)** 安裝在車尾的置物箱  
**JA** クルマのリアマウント型カーゴボックス  
**KO** 차량 후면에 장착하기 위한 카고 박스  
**TH** กล่องเก็บสัมภาระสำหรับติดตั้งที่ท้ายรถ  
**MS** Kotak kargo untuk pemasangan belakang pada kereta

### CITY CRASH

Complies with ISO norm

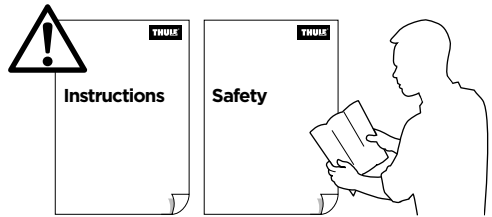

## Thule Arcos M/L

9061, 9062

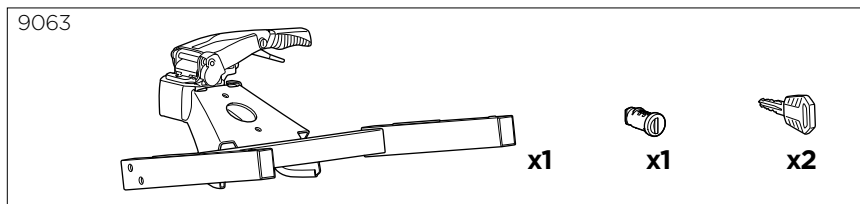
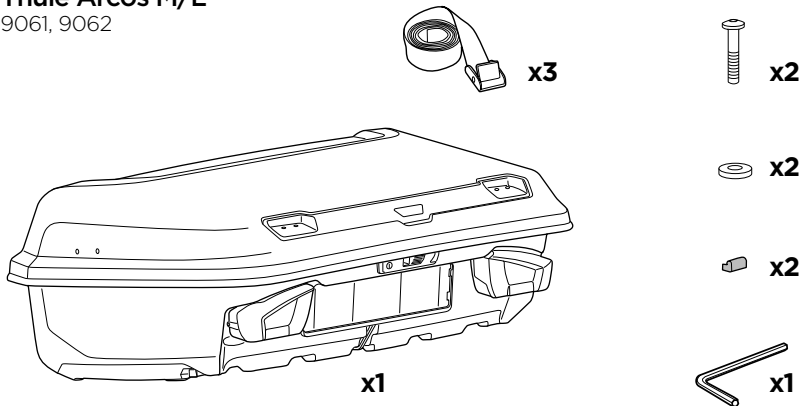

**i**

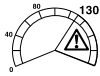
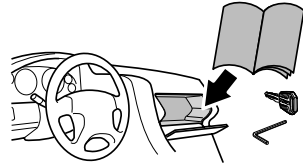
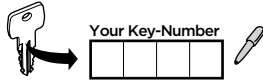

**Max 130 km/h**

**Max 50 kg**

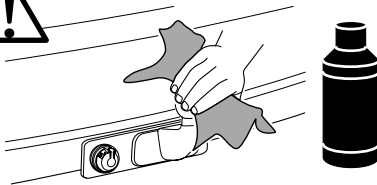
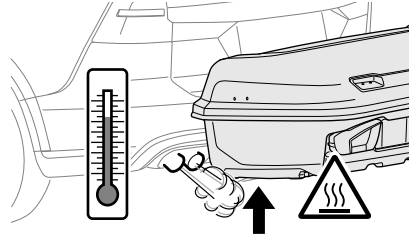
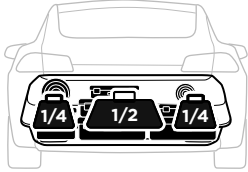

**D.1**  
Aluminium  
or GGG40

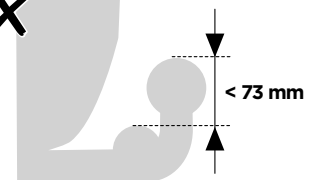
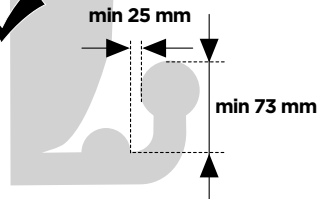
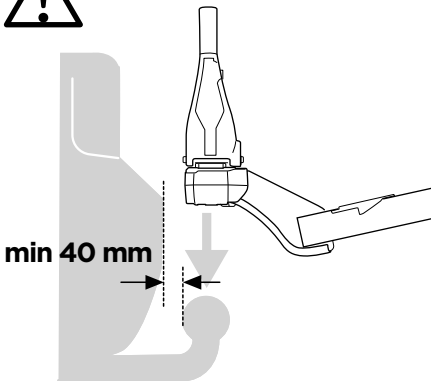

**i**

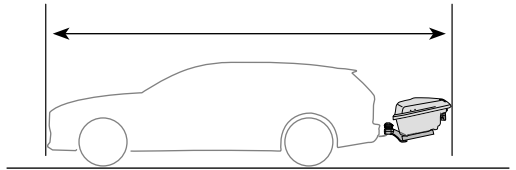
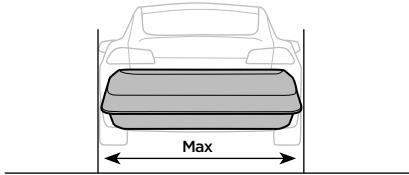
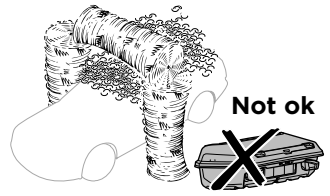
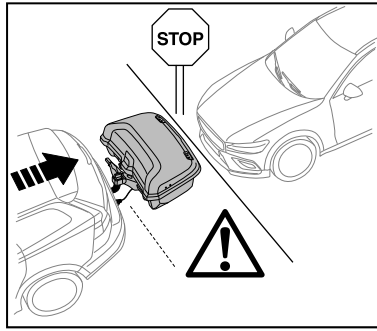

**Thule Arcos M**  
9064

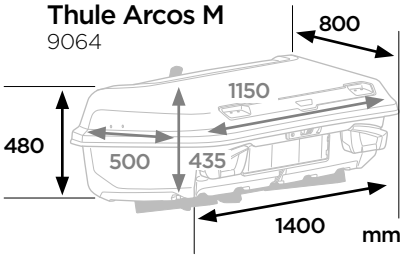

**Thule Arcos L**  
9065

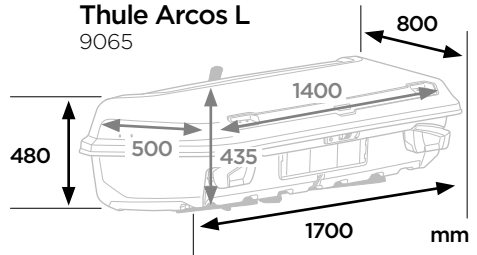

**Max ↓**



**M**



**L**

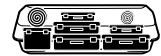

40 kg

50 kg

60 kg

70 kg

>80 kg

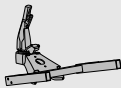

9 kg

**M**

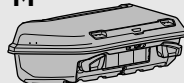

M 17 kg

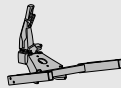

9 kg

**L**

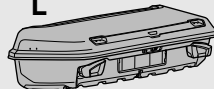

L 20 kg

Max 14 kg

Max 11 kg

Max 24 kg

Max 21 kg

Max 34 kg

Max 31 kg

Max 44 kg

Max 41 kg

Max 50 kg

Max 50 kg

1

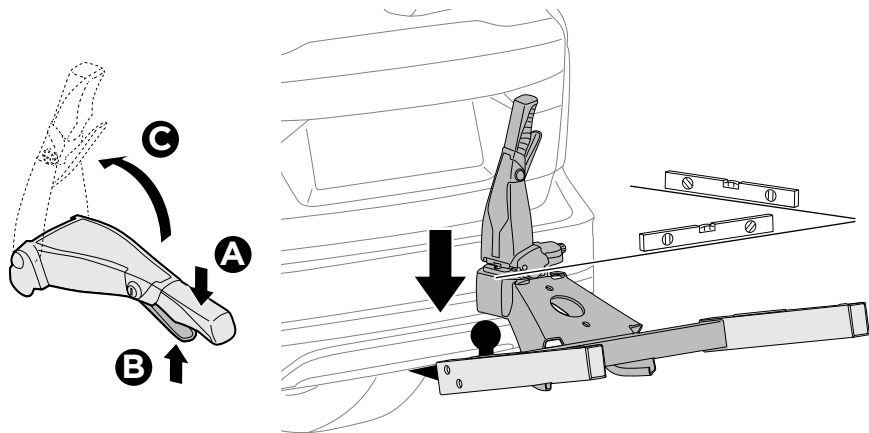
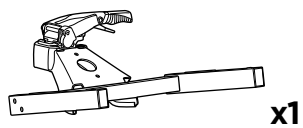

**i**

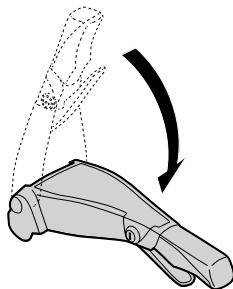
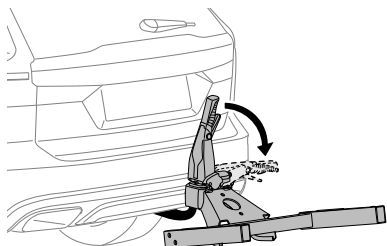
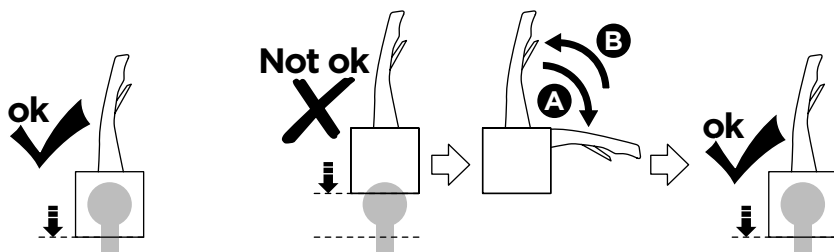

2

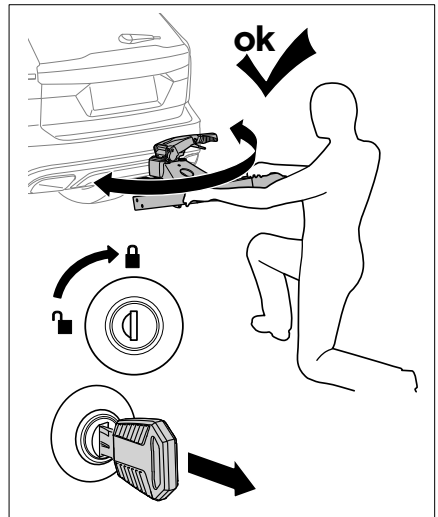
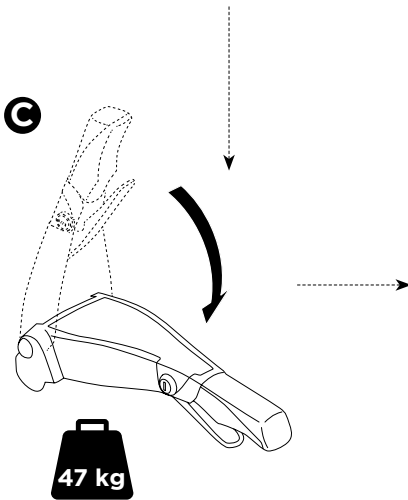
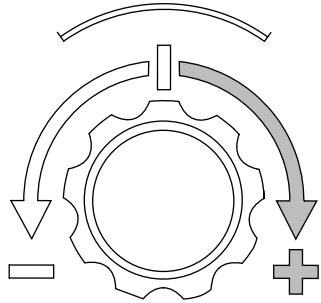
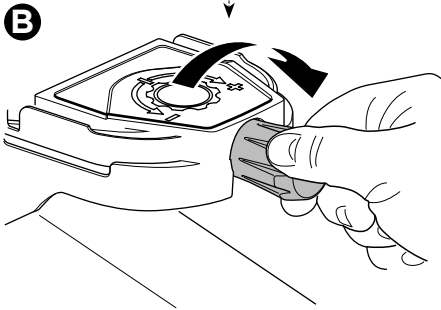
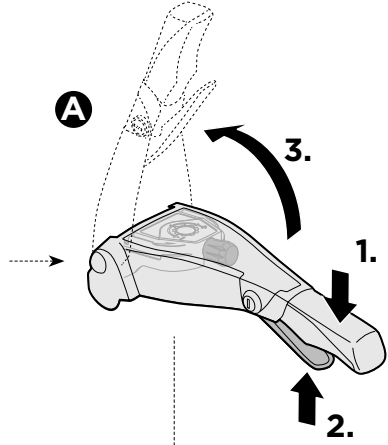
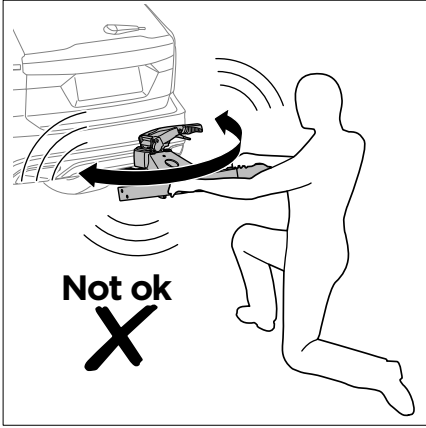

**3**

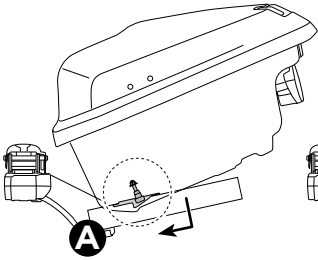
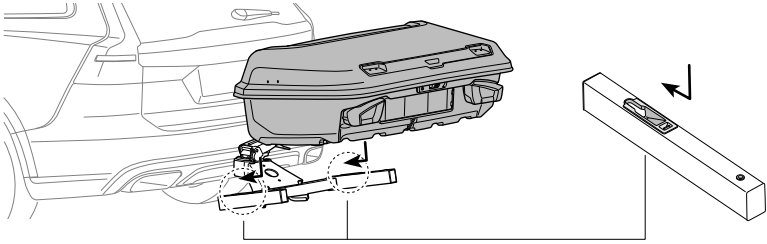

**A**

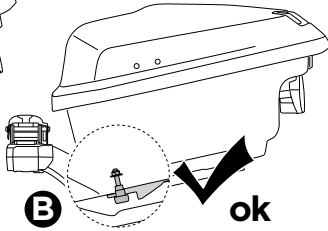

**B**

ok

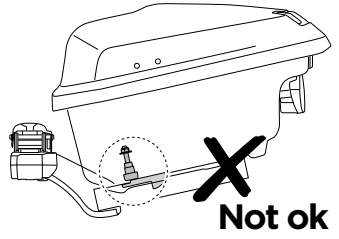

Not ok

**4**

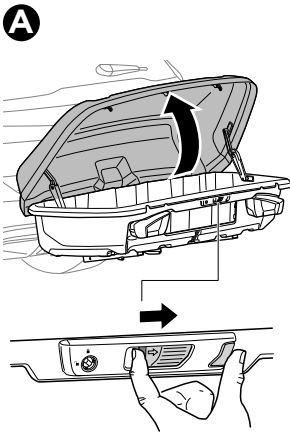

**A**

**B**

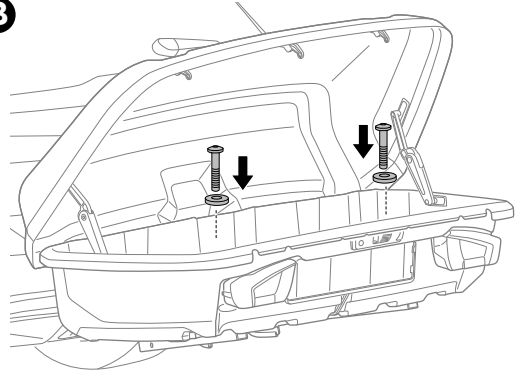

x2

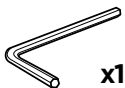

x1



x2

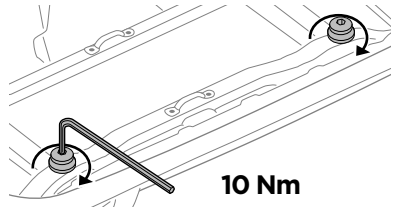

10 Nm

5

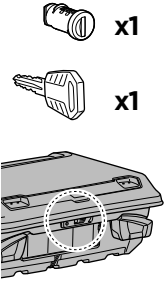
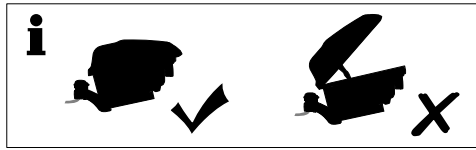

A

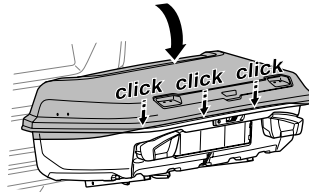

B

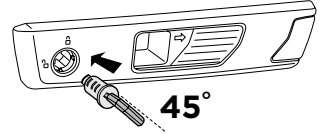

C

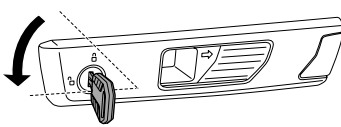

D

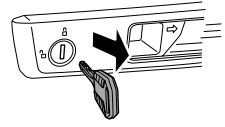

6

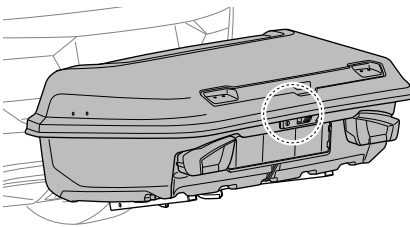

A

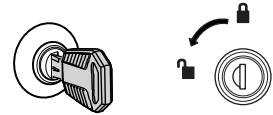

B

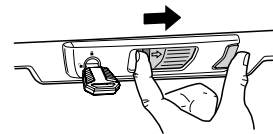

7

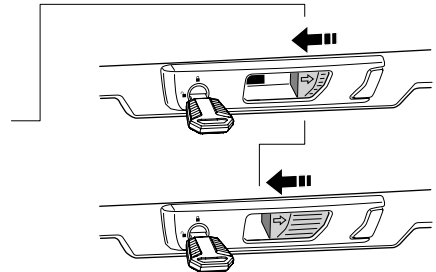
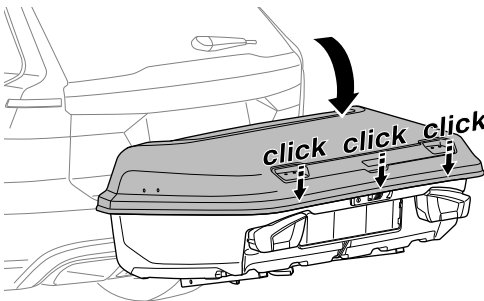

Not ok

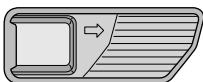

ok

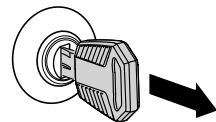
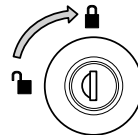



8

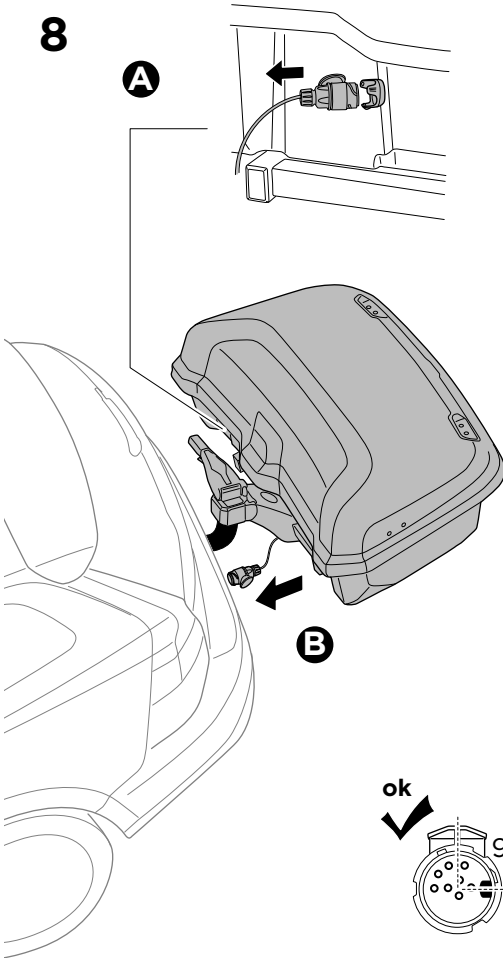

i

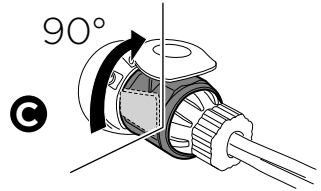
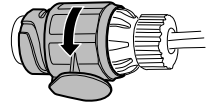
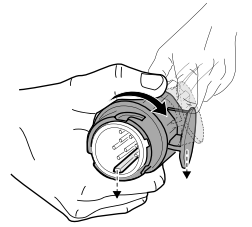

ok

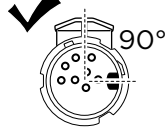

Not ok

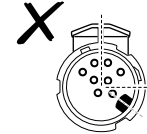

9

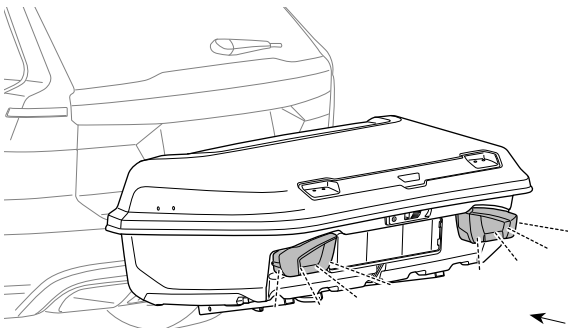

10

**i**

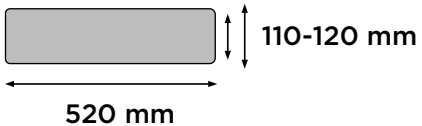

**A**

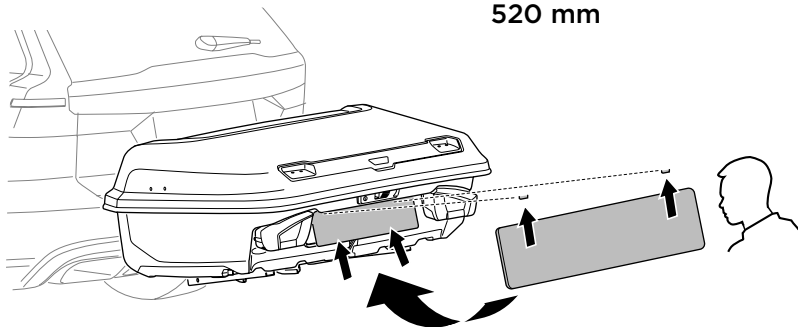

**B**

**x2**

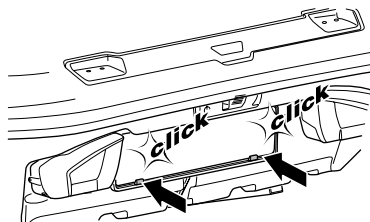
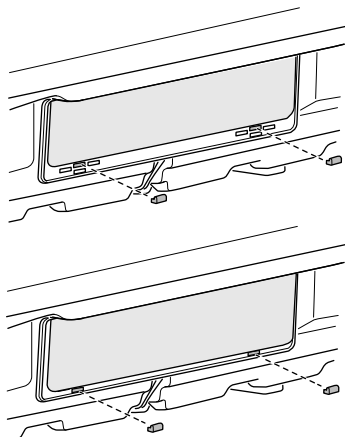

**i**

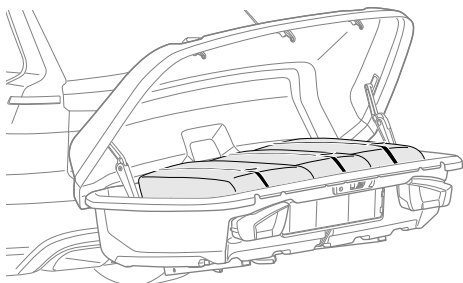
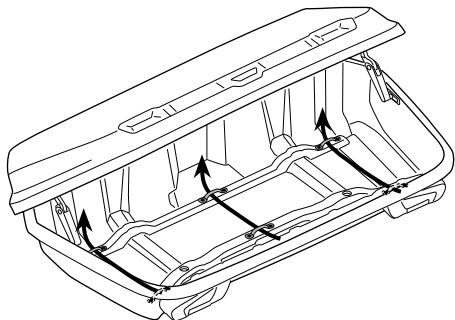
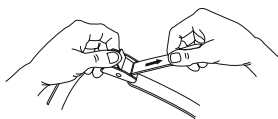

**i**

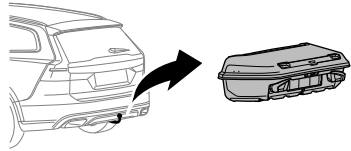
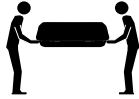

**1**

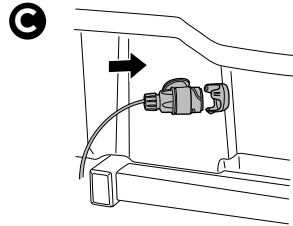
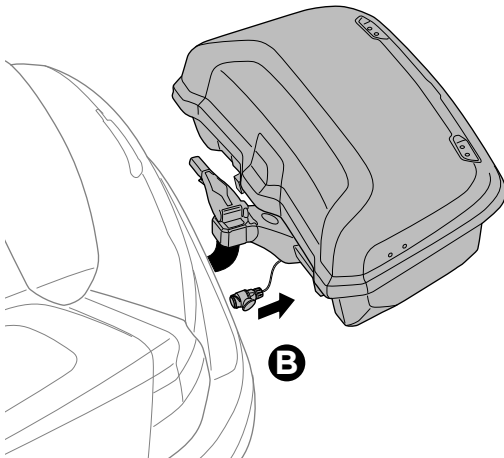
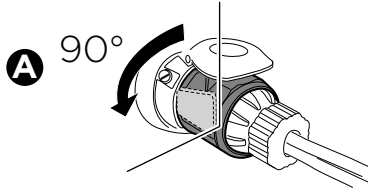

**2**

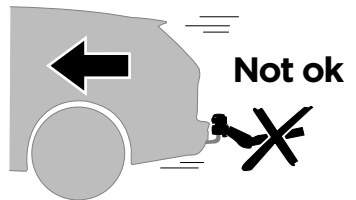
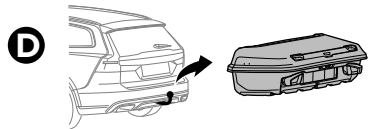
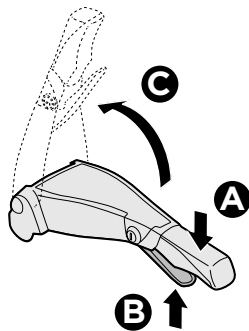



500 km

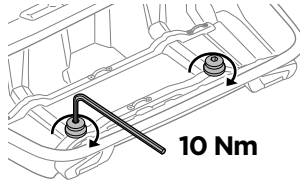

10 Nm

- 1: P21/5W      3: P21W
- 2: PY21W     4: C5W

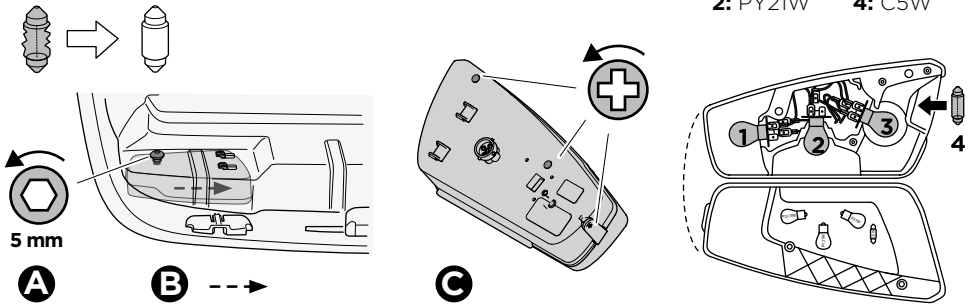

**EN** Accessories  
**FR** Accessoires  
**ES** Accesorios  
**DE** Zubehör  
**NL** Accessoires  
**PT** Acessórios  
**IT** Accessori  
**SV** Tillbehör  
**DK** Tilbehør

**NO** Tilbehør  
**FI** Lisävarusteet  
**IS** Aukabúnaður  
**ET** Lisavarustus  
**LV** Piederumi  
**LT** Priedai  
**RU** Аксессуары  
**UK** Аксесуары  
**PL** Akcesoria

**CS** Doplněk  
**HU** Tartozékok  
**RO** Accesorii  
**SK** Príslušenstvo  
**SL** Dodatki  
**BG** Принадлежности  
**HR** Dodaci  
**EL** Εξαρτάματα  
**TR** Aksesuarlar

**MT** Aċċessorji  
**HE** אביזרים  
**AR** ملحقات  
**ZH (CN)** 附件  
**ZH (TR)** 配件  
**JA** アクセサリー  
**KO** 액세서리  
**TH** อุปกรณ์เสริม  
**MS** Aksesori

**Thule Adapter 9906**  
 7-to-13-pin

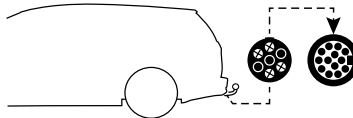

**Thule One-Key System**

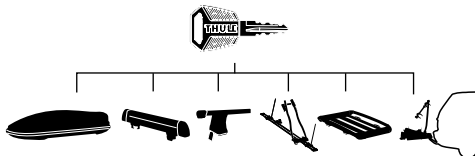

- 450400** (x4)
- 450600** (x6)
- 450800** (x8)
- 451200** (x12)
- 451600** (x16)